



# Your everyday LEDspot MR16

## Essential LEDspot MR16

Essential LEDspots MR16 are compatible with most existing fixtures with a GU5.3 socket and are designed as a retrofit replacement for halogen spots. Essential LEDspots MR16 deliver significant energy savings and minimise the initial investment.

### Benefits

- Up to 90 % energy saving compared with traditional halogen lamps
- Lower maintenance costs
- Low initial investment

### Features

- Easy retrofit
- Lifetime up to 15 000 hours
- Non-dimmable
- UV- and IR-free light

### Application

- Hotels, restaurants, bars, cafés, shops
- Lobbies, corridors, stairwells, washrooms, reception areas

# Essential LEDspot MR16

## Versions



## Dimensional drawing

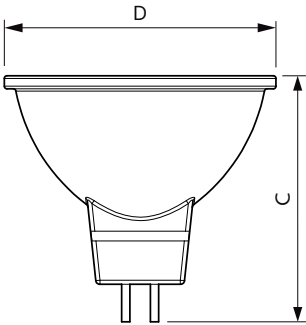

Product	D	C
Essential LED 5-50W 6500K MR16 24D	50 mm	46 mm
Essential LED 5-50W 2700K MR16 24D	50 mm	46 mm
ESS LED MR16 4.5-50W 36D 830 SO 100-240V	50.5 mm	46.5 mm
ESS LED MR16 4.5-50W 36D 865 SO 100-240V	50.5 mm	46.5 mm
ESS LED MR16 3-35W 36D 830 SO 100-240V	50.5 mm	46.5 mm
ESS LED MR16 3-35W 36D 865 SO 100-240V	50.5 mm	46.5 mm

### Controls and Dimming

Dimmable	No
----------	----

### Operating and Electrical

Starting Time (Nom)	0.5 s
---------------------	-------

### General Information

Cap-Base	GU5.3
Nominal Lifetime (Nom)	15000 h
Switching Cycle	50,000X

### Light Technical

Colour Rendering Index (Nom)	80
Llmf At End Of Nominal Lifetime (Nom)	70 %

### Mechanical and Housing

Bulb Shape	MR16
------------	------

## Approval and Application

Order Code	Full Product Name	Energy Consumption kWh/1000 h
929001240108	Essential LED 5-50W 2700K MR16 24D	- kWh
929001240208	Essential LED 5-50W 6500K MR16 24D	- kWh
929001874008	ESS LED MR16 4.5-50W 36D 830 SO 100-240V	4.5 kWh
929001874108	ESS LED MR16 4.5-50W 36D 865 SO 100-240V	4.5 kWh
929001874208	ESS LED MR16 3-35W 36D 830 SO 100-240V	3 kWh
929001874308	ESS LED MR16 3-35W 36D 865 SO 100-240V	3 kWh

## Operating and Electrical

## Essential LEDspot MR16

Order Code	Full Product Name	Input Frequency	Voltage (Nom)	Wattage Equivalent	Power (Rated) (Nom)
929001240108	Essential LED 5-50W 2700K MR16 24D	- Hz	12 V	50 W	5 W
929001240208	Essential LED 5-50W 6500K MR16 24D	- Hz	12 V	50 W	5 W
929001874008	ESS LED MR16 4.5-50W 36D 830 SO 100-240V	50 to 60 Hz	100-240 V	50 W	4.5 W
929001874108	ESS LED MR16 4.5-50W 36D	50 to 60 Hz	100-240 V	50 W	4.5 W

Order Code	Full Product Name	Input Frequency	Voltage (Nom)	Wattage Equivalent	Power (Rated) (Nom)
	865 SO 100-240V				
929001874208	ESS LED MR16 3-35W 36D 830 SO 100-240V	50 to 60 Hz	100-240 V	35 W	3 W
929001874308	ESS LED MR16 3-35W 36D 865 SO 100-240V	50 to 60 Hz	100-240 V	35 W	3 W

### Light Technical (1/2)

Order Code	Full Product Name	Beam Angle (Nom)	Colour Code	Correlated Colour Temperature (Nom)	Luminous Flux (Nom)
929001240108	Essential LED 5-50W 2700K MR16 24D	24 °	827	2700 K	400 lm
929001240208	Essential LED 5-50W 6500K MR16 24D	24 °	865	6500 K	435 lm
929001874008	ESS LED MR16 4.5-50W 36D 830 SO 100-240V	36 °	830	3000 K	400 lm

Order Code	Full Product Name	Beam Angle (Nom)	Colour Code	Correlated Colour Temperature (Nom)	Luminous Flux (Nom)
929001874108	ESS LED MR16 4.5-50W 36D 865 SO 100-240V	36 °	865	6500 K	400 lm
929001874208	ESS LED MR16 3-35W 36D 830 SO 100-240V	36 °	830	3000 K	230 lm
929001874308	ESS LED MR16 3-35W 36D 865 SO 100-240V	36 °	865	6500 K	230 lm

### Light Technical (2/2)

Order Code	Full Product Name	Luminous Intensity (Nom)
929001240108	Essential LED 5-50W 2700K MR16 24D	1700 cd
929001240208	Essential LED 5-50W 6500K MR16 24D	1700 cd
929001874008	ESS LED MR16 4.5-50W 36D 830 SO 100-240V	700 cd

Order Code	Full Product Name	Luminous Intensity (Nom)
929001874108	ESS LED MR16 4.5-50W 36D 865 SO 100-240V	700 cd
929001874208	ESS LED MR16 3-35W 36D 830 SO 100-240V	550 cd
929001874308	ESS LED MR16 3-35W 36D 865 SO 100-240V	550 cd

### Temperature

Order Code	Full Product Name	T-Case Maximum (Nom)
929001240108	Essential LED 5-50W 2700K MR16 24D	76 °C
929001240208	Essential LED 5-50W 6500K MR16 24D	76 °C
929001874008	ESS LED MR16 4.5-50W 36D 830 SO 100-240V	65 °C
929001874108	ESS LED MR16 4.5-50W 36D 865 SO 100-240V	65 °C
929001874208	ESS LED MR16 3-35W 36D 830 SO 100-240V	55 °C
929001874308	ESS LED MR16 3-35W 36D 865 SO 100-240V	55 °C

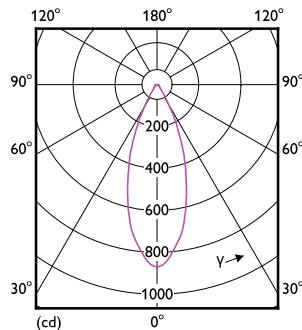

# Essential LEDspot MR16

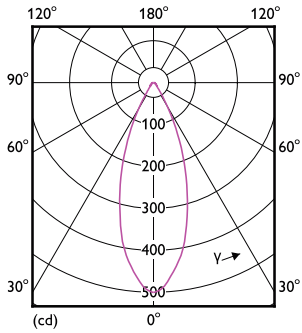

## Accent Diagrams

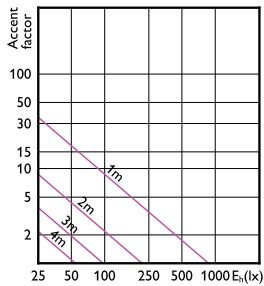

50W GU5-3 MR16 36D 830 3000K

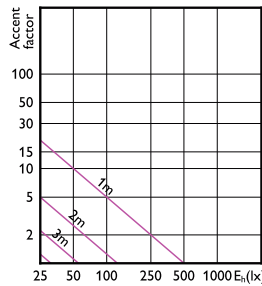

3-35W GU5-3 MR16 36D 865 6500K

## Beam Diagrams

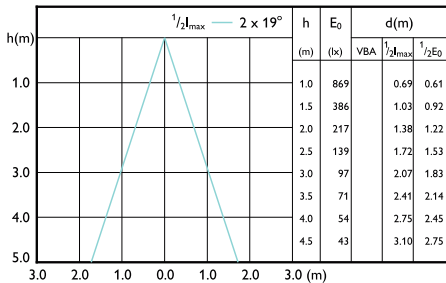

50W GU5-3 MR16 36D 830 3000K

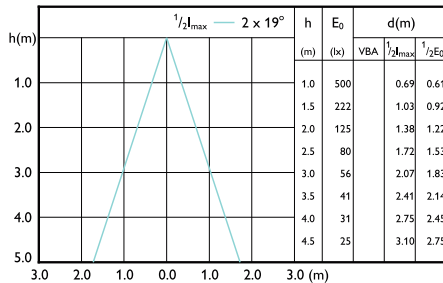

3-35W GU5-3 MR16 36D 865 6500K

