



PrimaVision Compact for CDM

HID-PV C 70 /S CDM 220-240V 50/60Hz NG

High-quality, compact and lightweight HID electronic gear for optimal and reliable performance of 20, 35, 50 and 70 W CDM lamps

Product data

General Information	
Type version	ng
Lamp type	CDM
Number of lamps	1 piece/unit
Suitable for outdoor use	No
Number of products on MCB (16 A type B) (nom.)	20
Automatic restart	Yes
Operating and Electrical	
Input Voltage	220 to 240 V
Input frequency	50 to 60 Hz
Operating frequency (nom.)	0.14 kHz
Power factor 100% load (nom.)	0.95
Ignition voltage (max.)	4.0 kV
Ignition switch-off time (nom.)	18 min
Mains voltage performance (AC)	-10%/+6%
Mains voltage safety (AC)	-18%/+10%
Inrush current width	0.33 ms
Constant wattage deviation	-3%/+3%
Power losses (nom.)	7.0 W
Inrush current peak (max.)	33 A

Efficiency at full load [%]	90.6 %
Wiring	
Cable capacity output wires mutual (nom.)	100 pF
Cable length from device to lamp	1.5 m
Ballast contact wire cross section	0.50-2.50 mm ²
Connector type	Insert
System characteristics	
Rated ballast-lamp power	70 W
Temperature	
T-ambient (max.)	50 °C
T-ambient (min.)	-20 °C
T storage (max.)	80 °C
T storage (min.)	-25 °C
T-case lifetime (nom.)	80 °C
T-Case maximum (max.)	80 °C
Mechanical and Housing	
Housing	/S

PrimaVision Compact for CDM

Approval and Application

Active temperature protection	Yes
EMI 9 kHz ... 300 MHz	CISPR 15 ed 7.2
Safety standard	EN 61347-2-12
Quality standard	ISO 9000:2000
Environmental standard	ISO 14001
Harmonic current emission standard	EN 61000-3-2
EMC immunity standard	EN 61547
Vibration standard	IEC68-2-6 F c
Bumps standard	IEC 68-2-29 Eb
Humidity standard	IEC 928-13
Approval marks	CE marking ENEC certificate
Humming and noise level	37 dB(A)

Product Data

Full product code	872790085974400
Order product name	HID-PV C 70 /S CDM 220-240V 50/60Hz NG
EAN/UPC – product	8711500881694
Order code	913700652966
SAP numerator – quantity per pack	1
Numerator – packs per outer box	12
SAP material	913700652966
SAP net weight (piece)	0.216 kg

Dimensional drawing

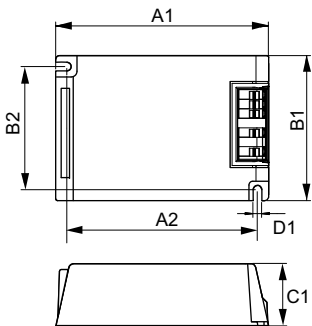

HID-PV C 70 /S CDM 220-240V 50/60Hz NG

Product	D1	C1	A1	A2	B1	B2
HID-PV C 70 /S CDM	4.9 mm	32.2	109.6	98.5	74.4	63.7
220-240V 50/60Hz NG		mm	mm	mm	mm	mm

